

Mechanical No Loss Drains

340-11-015HC BSP

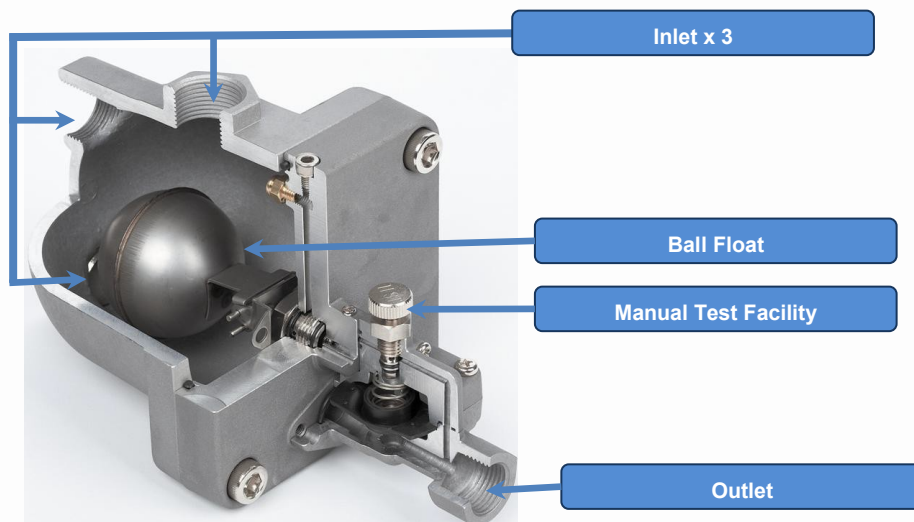

The Mechanical No Loss Drain removes harmful condensate from receiver tanks, aftercoolers, dryers, filters and drip legs



- ✓ **Reliable**
- ✓ **Fully Automatic**
- ✓ **Compact**
- ✓ **Rugged**
- ✓ **No Electricity**
- ✓ **No Air Loss**
- ✓ **Manual Test Function**
- ✓ **Easy Service**
- ✓ **Easy Installation**
- ✓ **Available in Three Pressure Ranges**
- ✓ **Models for both Oil-free and Oil Injected Application**

Description

- ◆ Initial, diaphragm is kept by system pressure
- ◆ Condensate collects inside the unit through the inlet, gradually causing the ball float to rise
- ◆ Upon reaching a predetermined height, the ball float opens the pilot valve. This relieves the pressure chamber above the diaphragm.
- ◆ As a result, the pressure of the condensate lifts the diaphragm, allowing the collected condensate to be discharged.
- ◆ As the condensate is discharged, the float sinks, closing the pilot valve. Compressed air then flows over the diaphragm, sealing it again.

Benefits/Features

- ◆ Improves air system performance
- ◆ Eliminates frequent downtime maintenance
- ◆ Prevents corrosion and scaling
- ◆ Increase the air-carrying capacity of the pipelines
- ◆ Extends equipment life
- ◆ Aluminium body with stainless steel internals
- ◆ Maximum working pressure up to 250 PSI
- ◆ Manual test function
- ◆ 7mm outlet for quick discharge of condensate
- ◆ Optional extras include a heating unit to prevent freezing and bursting of pipelines in the winter and pre-filter ball valves to prolong lifespan of the unit

Mechanical No Loss Drains

340-11-015HC BSP



Technical Specification

Technical Data				
Air Compressor Performance (MAX)	50m ³ /min			
Natural Flow Volume	3 l/hr			
Operating Pressure (min/max)	10—16 bar			
Short Term Peak Load (From 7 bar)	15 l/hr			
Temperature (Min/Max)	+0°C to +60°C			
Condensate Inlet	1/2" x 3			
Condensate Discharge	3/8" x 1			
Thread Type	BSP			
Weight	1.2 Kg			
Application	Oil Free Compressor			
Overall Dimension	A	B	C	D
	1/2"	3/8"	105mm	186mm

Dimensions

