

# 1/2" Programmable MBV

## 743-01-001

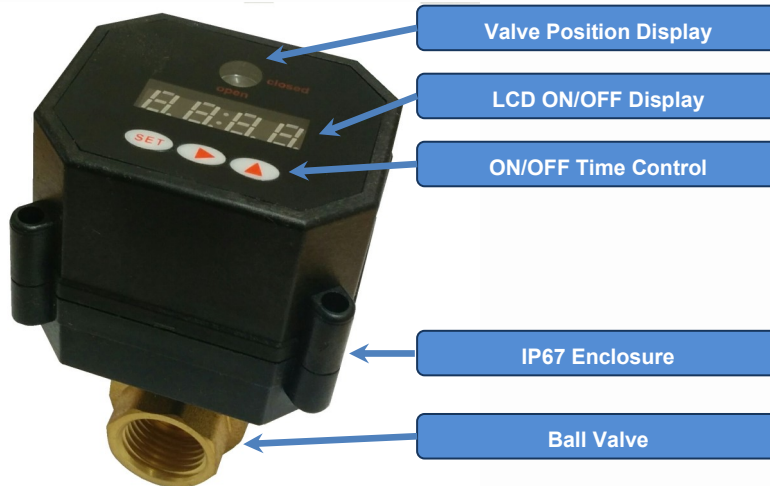

### Features

- ◆ Complete Assembly ready to plug & play
- ◆ >100,000 life cycles
- ◆ Max working pressure of 16 bar
- ◆ User friendly ON/OFF timer control
- ◆ Very Compact Design
- ◆ 110-230 VAC 50/60 Hz supply
- ◆ OEM branding available

### Description

The **Powerflow Motorized Ball Valve/Drain Valve** offers users a non-block approach to condensate removal from compressed air systems. Removal of condensate from compressed air systems is a critical maintenance requirement. Failure to carry out regular draining results in serious disruption to production schedules, deterioration in product quality, damage to sensitive pneumatic equipment, etc.

The **Powerflow Motorized Ball Valve/Drain Valve** offers an open time of <7secs, with in-built stall current that prevents motor damage. The **Powerflow Motorized Ball Valve/Drain Valve** is available with programmable and non-programmable options, in brass or stainless steel and in a variety of valve sizes.

The user interface on the programmable option allows maintenance personnel to see via the LCD display the time remaining before the valve is due to open. This allows for accurate and efficient ON/OFF time adjustment.

### Technical Specification

Specification: Model	
Rated Voltage	110 - 230 VAC 50-60Hz
Current	500 mA
Life Cycle	150,000 Cycles
Cable Length	2m
Operational Temperature	-15 - +50°C
Manual Override	No
Visual Indicator	Yes
IP Rating	IP67
Stall Current	600 mA
Media Max Temperature	2 - 90°C
One Direction Open/Close Time	<7 secs 90°
Valve Position if Power Removed	NC
Valve Material	Brass



Every effort has been taken to ensure the accuracy of this specification. However in order to maintain our technological lead we are continuously improving our products which could, without notice result in amendments or omissions to this specification. We cannot accept responsibility for damage, injury, loss or expenses resulting therein.



# 1/2" Programmable MBV

## 743-01-001



### Description

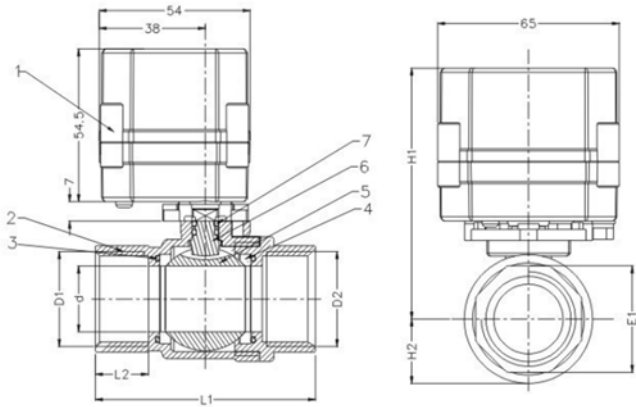

NO.	NAME	MATERIAL	QTY
1	Electronic Enclosure	PPO	1
2	Body cover	SS/Brass	1
3	O-ring	FKM	2
4	Sealing	PTFE	2
5	Ball	Stainless Steel	1
6	Stem	Stainless Steel	2
7	O-ring	FKM	2

Part	D1/D2	d	L1	L2	E1	H1	H2
1/4" Valve	1/4"	8	50	12	21	80	14
1/2" Valve	1/2"	15	63	14	25	83	17
3/4" Valve	3/4"	20	66	15	31	87	20
1" Valve	1"	25	72	16	38	95	24
1 1/4" Valve	1 1/4"	29	77	16	46	105	28